

LEM SOFA

by Francesco Beghetto

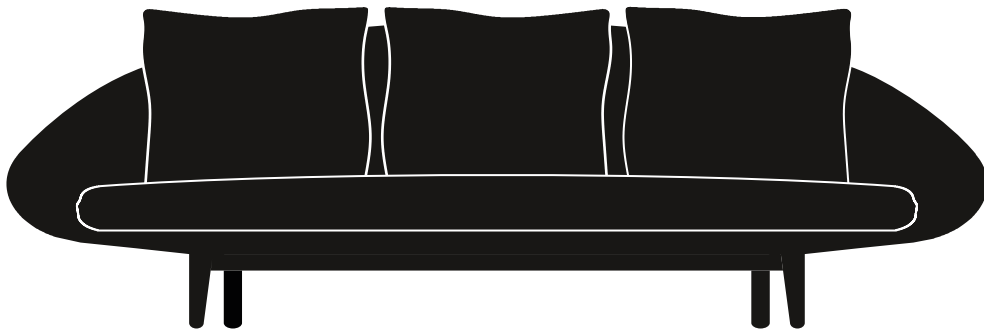

Lem è un divano morbido e sinuoso, con una struttura interamente rivestita in tessuto, che si slancia verso l'alto con dolci piedini. I morbidi cuscini della seduta e dello schienale si appoggiano sul guscio di tessuto garantendo il massimo comfort. La serie Lem è completa di quattro varianti, divano due e tre posti, poltroncina e ottomana.

Lem is soft and sinuous sofa; the tubular structure with the aid of straps, is fully covered in fabric without using foams. Soft seat cushions and back rest on the shell fabric to ensure maximum comfort. The series LEM is complete of four variants, two or three seater sofa, armchair and ottoman.

DIMENSIONI | DIMENSIONS

DUE POSTI | TWO SEATS

lunghezza | width: 210 cm
larghezza | depth: 104 cm
altezza | height: 88 cm
altezza del sedile | seat height: 46cm

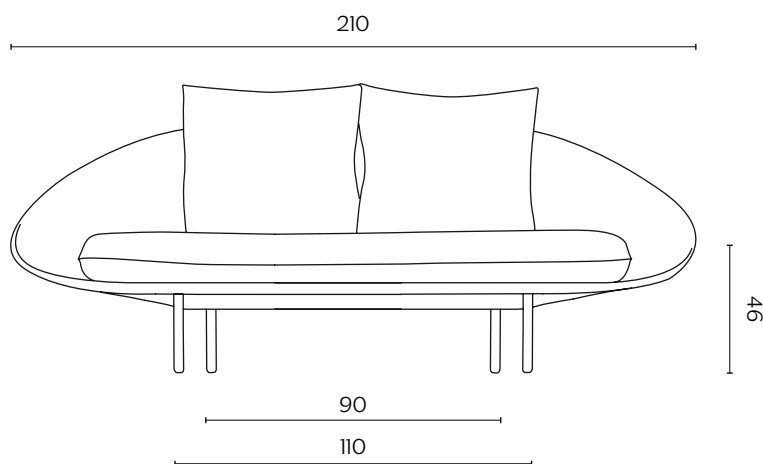
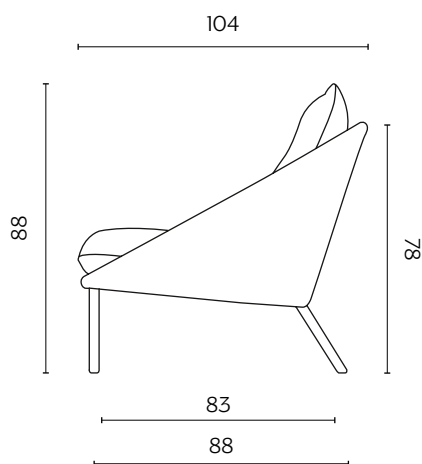

TRE POSTI | THREE SEATS

lunghezza | width: 267 cm
larghezza | depth: 104 cm
altezza | height: 88 cm
altezza del sedile | seat height: 46 cm

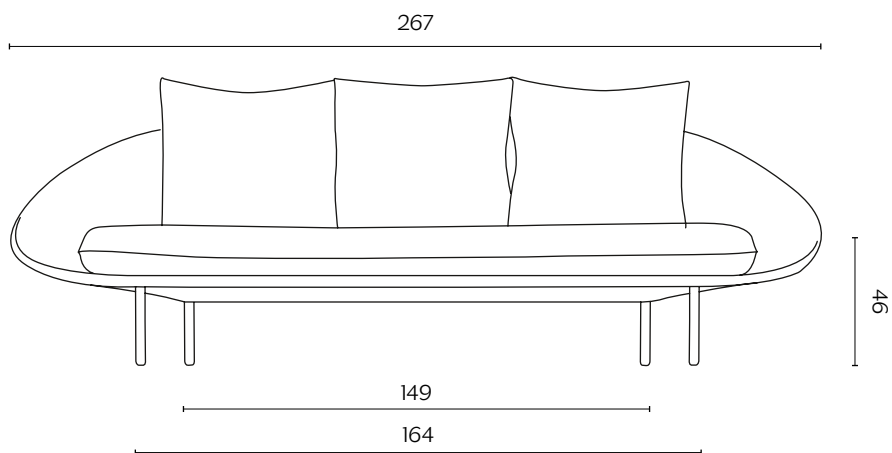
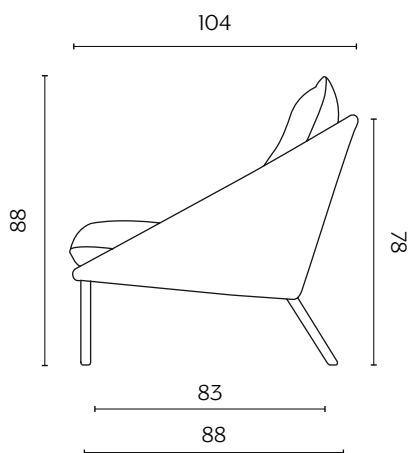

TESSUTI | FABRICS

A

LOOP

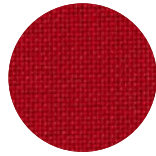

Rosso

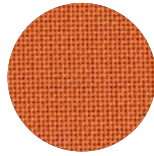

Arancione



Blu notte



Cioccolato



Burro

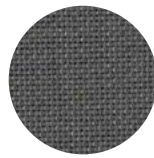

Grigio fumo



Nero

TRAMÈ

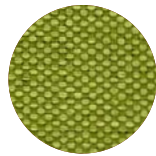

Mela

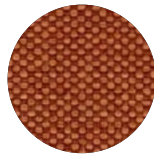

Arancio

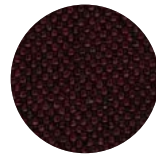

Uva



Nero

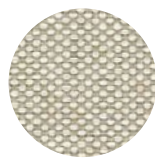

Beige

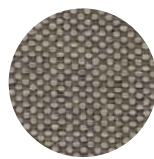

Tortora



Grigio scuro

TESSUTI | FABRICS

A

CANVA



Ciallo

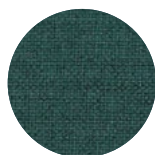

Petrolio

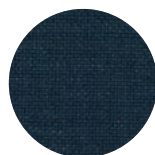

Blu



Sale



Sabbia

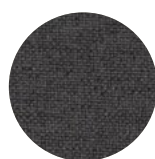

Grigio scuro

PEPLO



Cannella



Rosso mattone



Giallo ocra



Grigio chiaro



Grigio tortora

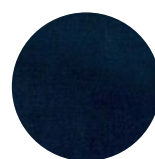

Blu notte

TESSUTI | FABRICS

B

FLUKSO PLATINUM



Pesca



Mattone

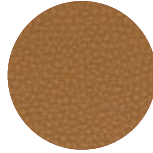

Nocciola



Verde

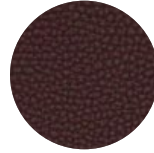

Porpora



Tortora

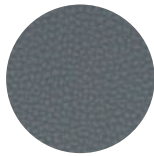

Nuvoloso

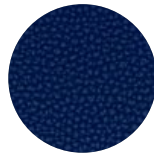

Blu

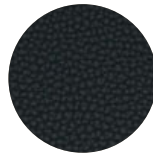

Nero

TESSUTI | FABRICS

B

VESCOM WILSON

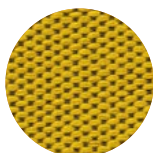

Ciallo elettrico

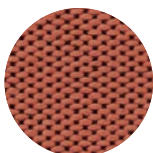

Rosé

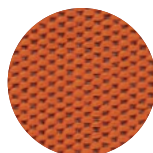

Energico

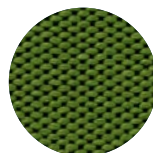

Laguna

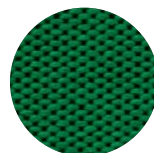

Prato

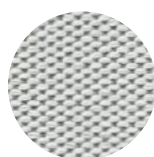

Neve

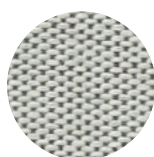

Sale e pepe

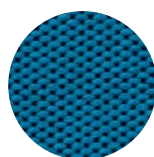

Zaffiro

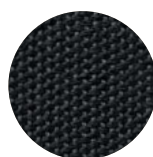

Crafite

VESCOM NORFOLK



Ape



Rosa

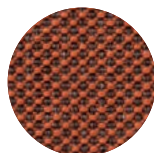

Mattone

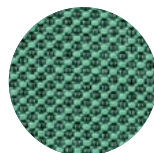

Latte e menta



Petrolio

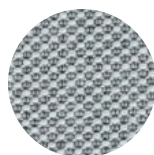

Chiaccio



Sale e pepe



Notte



Antracite

TESSUTI | FABRICS

C

KVADRAT RELATE

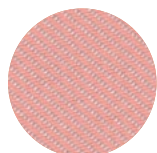

Rosa

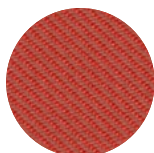

Rosso

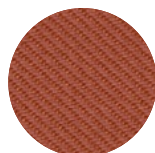

Terra



Snack



Menta

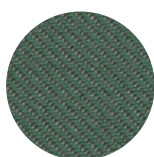

Verde bosco



Nuvolo



Grigio

KVADRAT FIELD 2

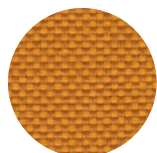

Zafferano

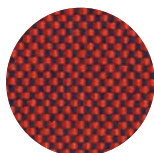

Ciliegia

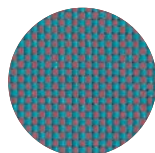

Zucchero

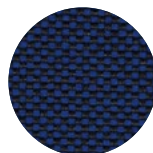

Blu

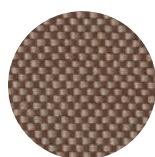

Nocciola

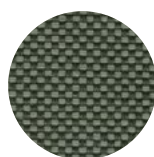

Menta

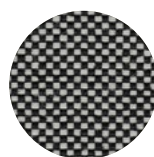

Sale e pepe

TESSUTI | FABRICS

C

VESCOM HARDING

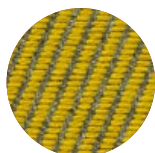

Ciallo



Rosso

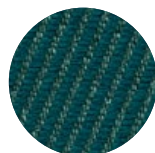

Petrolio



Nuvolo



Crigio chiaro

VESCOM ROLLA



Mostarda

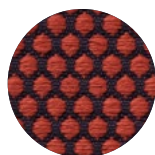

Ciliegia

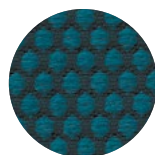

Blu pavone



Latte

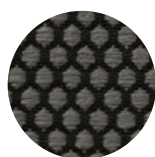

Crafite



Blu notte

TESSUTI | FABRICS

C

VESCOM MOORE

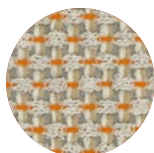

Margherita

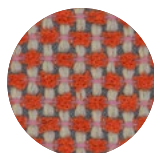

Lampone

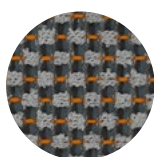

Saetta

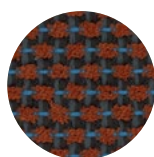

Uva

TORRILANA GUBBIO

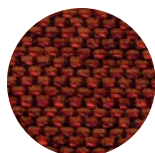

Ambra

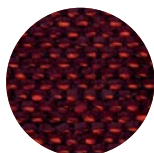

Bordeaux

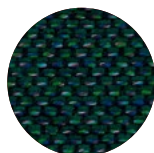

Verde Petrolio

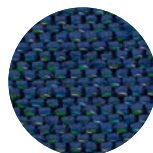

Blu elettrico

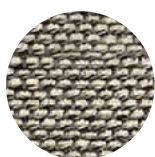

Sale e pepe



Castagna



Tortora

TESSUTI | FABRICS

C

BIG BOSS



Nuvola



Senape



Nocciola

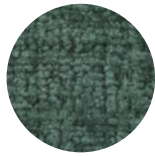

Turchese

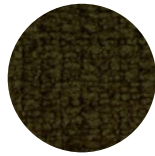

Muschio



Porpora

MAHARAM METRIC

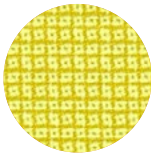

Canary

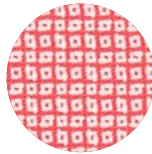

Cala



Lava

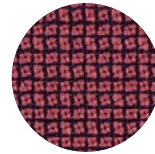

Kiln

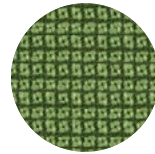

Alligator

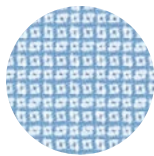

Middy



Talisman

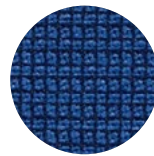

Seaport

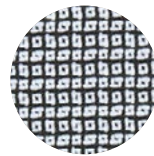

Film

TESSUTI | FABRICS

D

MAHARAM MERIT



Salmone

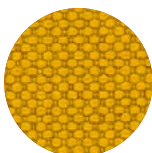

Ciallo

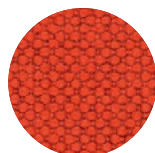

Rosso corallo

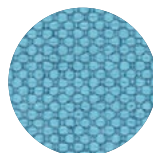

Celeste



Marrone

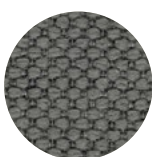

Grigio



Sale e pepe

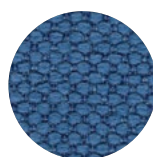

Blu cobalto

ROHI SERA

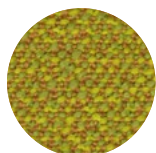

Tivoli

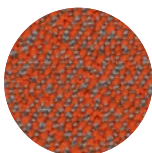

Glow

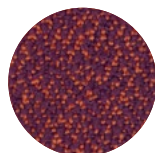

Berry

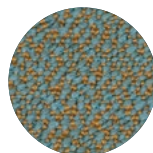

Mirage



Pepper

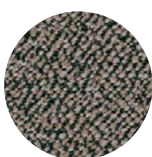

Walnut



Rosewood

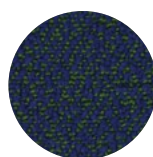

Mare

TESSUTI | FABRICS

D

ROHI MICA



Sanddorn



Indio

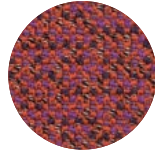

Brevia

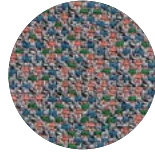

Papillon



Calla



Crisp

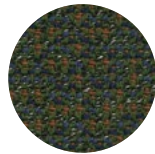

Jungle

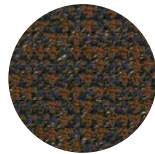

Secret

ROHI CLEO



Lemon

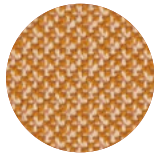

Peach

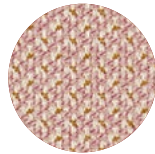

Flamingo

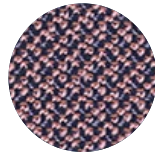

Azalee

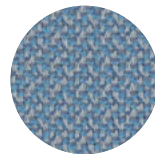

Sky



Ocean

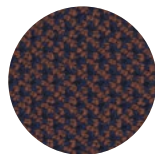

Magma



Pepper

TESSUTI | FABRICS

D

ERIMITI CLOUD



Panna



Noce



Nocciola



Bordeaux

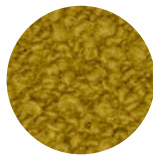

Senape

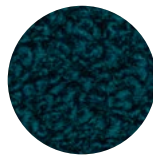

Petrolio



Blu notte

TORRILANA BRIONNE

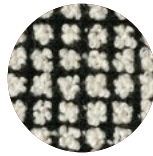

Black and white

TESSUTI | FABRICS

E

KVADRAT STEEL CUT TRIO 3

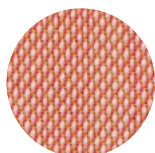

Pesca

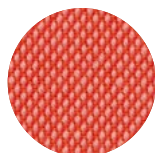

Arancia rossa

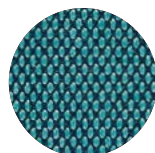

Pavone

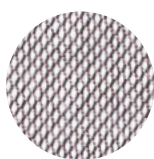

Sale e pepe

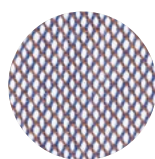

Elettricità

DEDAR SANSONE



Torunesol



Zucca

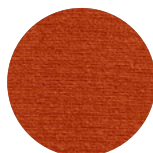

Persia



Cactus



Havane



Champagne



Terre d'ombre



Ebano



Encre

TESSUTI | FABRICS

E

DEDAR VOULEZ-VOUS



Sambuco



Cirasole

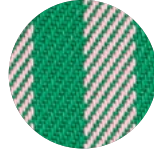

Fragola e menta



Tiramisu



Amarena



Tabacco



Noce di cocco

TESSUTI | FABRICS

F

KVADRAT SUUNTA

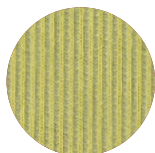

Primavera



Narcis

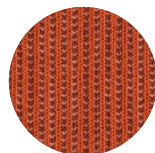

Tulip

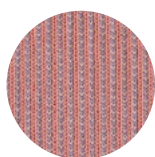

Peony

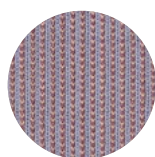

Crocus

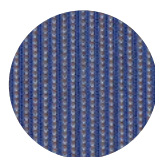

Iris

KVADRAT TERO OUT

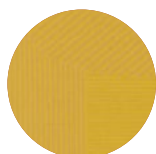

Sole



Verde prato



Borgogna

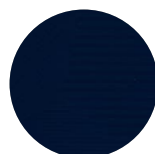

Notte



Panna



Nuvole

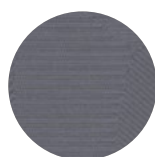

Robot



Tabacco

TESSUTI | FABRICS

F

MAHARAM OXBOW



Dianthus

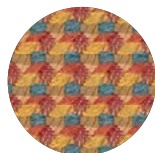

Montage

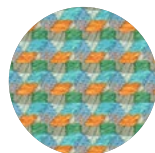

Noveau

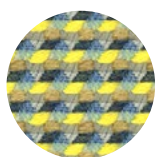

Legume

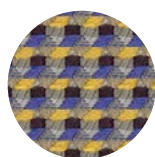

Module

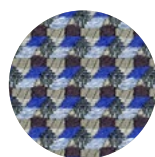

Trope

SAHCO ZERO

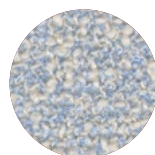

Zucchero

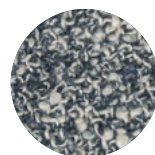

Petrolio



Sale e pepe

TESSUTI | FABRICS

C

DEDAR TIGER BEAT

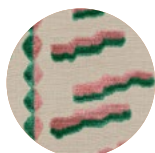

Fragola menta

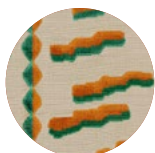

Papaya



Fauve



Tabacco



Fumo

DEDAR AMULETO



Corallo



Rubino

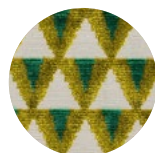

Smeraldo



Alabastro



Occhio di tigre